

## Features

- Dual N-Channel MOSFET
- Low On-Resistance
- Low Gate Threshold Voltage
- Low Input Capacitance
- Fast Switching Speed
- Low Input/Output Leakage
- Ultra-Small Surface Mount Package
- **Lead Free By Design/RoHS Compliant (Note 2)**
- **ESD Protected Up To 2kV**
- **"Green" Device (Note 4)**

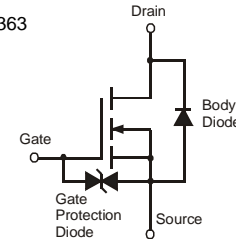

SOT-363

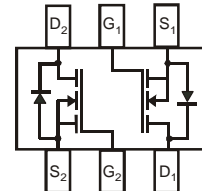

EQUIVALENT CIRCUIT PER ELEMENT

 TOP VIEW  
Internal Schematic

## Mechanical Data

- Case: SOT-363
- Case Material: Molded Plastic, "Green" Molding Compound. UL Flammability Classification Rating 94V-0
- Moisture Sensitivity: Level 1 per J-STD-020C
- Terminals Connections: See Diagram
- Terminals: Finish - Matte Tin annealed over Alloy 42 leadframe. Solderable per MIL-STD-202, Method 208
- Marking Information: See Page 4
- Ordering Information: See Page 4
- Weight: 0.006 grams (approximate)

## Maximum Ratings @ $T_A = 25^\circ\text{C}$ unless otherwise specified

Characteristic	Symbol	Value	Unit
Drain Source Voltage	$V_{DSS}$	60	V
Gate-Source Voltage	$V_{GSS}$	$\pm 20$	V
Drain Current (Note 1)	$I_D$	305 800	mA
		Continuous Pulsed (Note 3)	

## Thermal Characteristics @ $T_A = 25^\circ\text{C}$ unless otherwise specified

Characteristic	Symbol	Value	Unit
Total Power Dissipation (Note 1)	$P_D$	200	mW
Thermal Resistance, Junction to Ambient	$R_{\theta JA}$	625	$^\circ\text{C/W}$
Operating and Storage Temperature Range	$T_j, T_{STG}$	-65 to +150	$^\circ\text{C}$

## Electrical Characteristics @ $T_A = 25^\circ\text{C}$ unless otherwise specified

Characteristic	Symbol	Min	Typ	Max	Unit	Test Condition
<b>OFF CHARACTERISTICS (Note 5)</b>						
Drain-Source Breakdown Voltage	$BV_{DSS}$	60	—	—	V	$V_{GS} = 0V, I_D = 10\mu A$
Zero Gate Voltage Drain Current	$I_{DSS}$	—	—	1	$\mu A$	$V_{DS} = 60V, V_{GS} = 0V$
Gate-Source Leakage	$I_{GSS}$	—	—	$\pm 10$	$\mu A$	$V_{GS} = \pm 20V, V_{DS} = 0V$
<b>ON CHARACTERISTICS (Note 5)</b>						
Gate Threshold Voltage	$V_{GS(th)}$	1.0	1.6	2.5	V	$V_{DS} = 10V, I_D = 1mA$
Static Drain-Source On-Resistance	$R_{DS(ON)}$	—	—	2.0 3.0	$\Omega$	$V_{GS} = 10V, I_D = 0.5A$ $V_{GS} = 5V, I_D = 0.05A$
Forward Transfer Admittance	$ Y_{fs} $	80	—	—	ms	$V_{DS} = 10V, I_D = 0.2A$
Diode Forward Voltage (Note 5)	$V_{SD}$	0.5	—	1.4	V	$V_{GS} = 0V, I_S = 115mA$
<b>DYNAMIC CHARACTERISTICS</b>						
Input Capacitance	$C_{iss}$	—	—	50	pF	$V_{DS} = 25V, V_{GS} = 0V$ $f = 1.0MHz$
Output Capacitance	$C_{oss}$	—	—	25	pF	
Reverse Transfer Capacitance	$C_{rss}$	—	—	5.0	pF	

- Notes:
1. Device mounted on FR-4 PCB.
  2. No purposefully added lead.
  3. Pulse width  $\leq 10\mu s$ , Duty Cycle  $\leq 1\%$ .
  4. Diodes Inc.'s "Green" policy can be found on our website at [http://www.diodes.com/products/lead\\_free/index.php](http://www.diodes.com/products/lead_free/index.php).
  5. Short duration pulse test used to minimize self-heating effect.

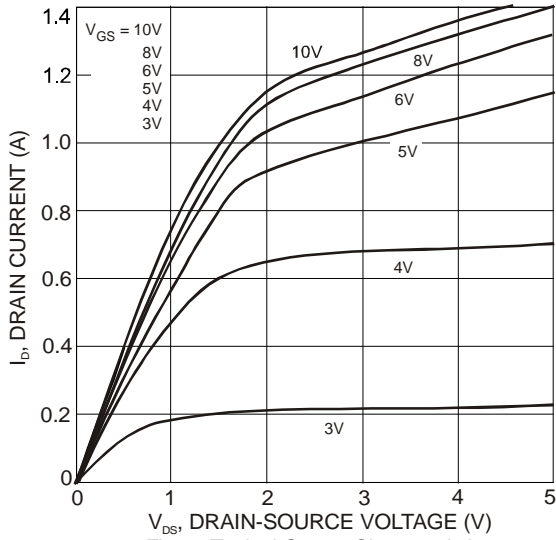

Fig. 1 Typical Output Characteristics

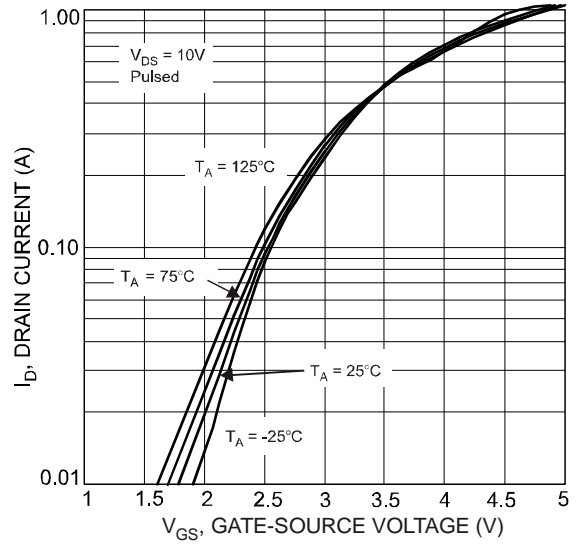

Fig. 2 Typical Transfer Characteristics

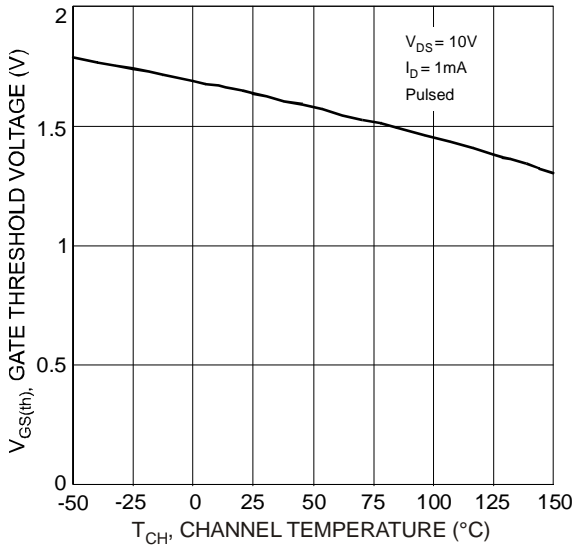

Fig. 3 Gate Threshold Voltage vs. Channel Temperature

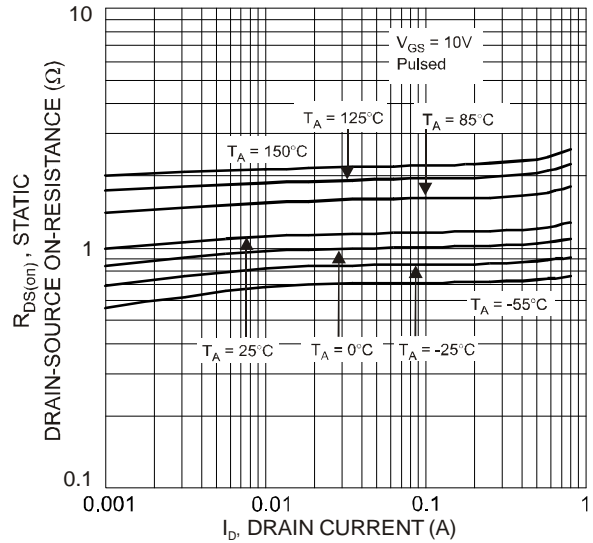

Fig. 4 Static Drain-Source On-Resistance vs. Drain Current

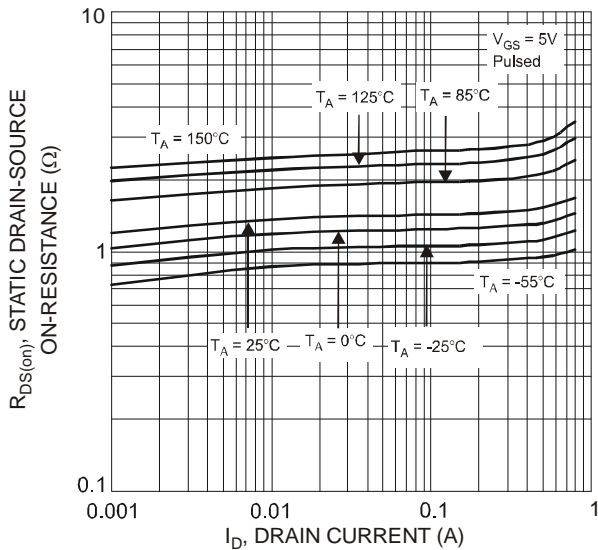

Fig. 5 Static Drain-Source On-Resistance vs. Drain Current

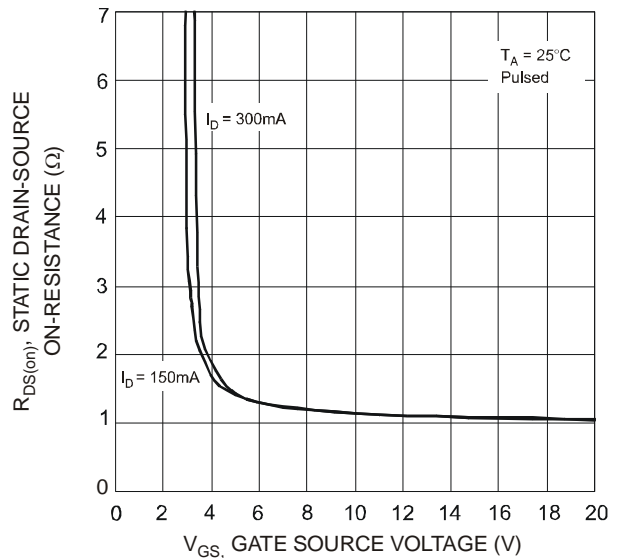

Fig. 6 Static Drain-Source On-Resistance vs. Gate-Source Voltage

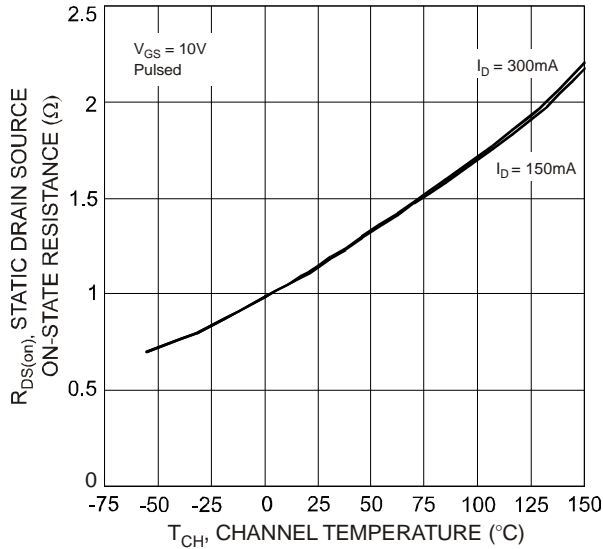

Fig. 7 Static Drain-Source On-State Resistance vs. Channel Temperature

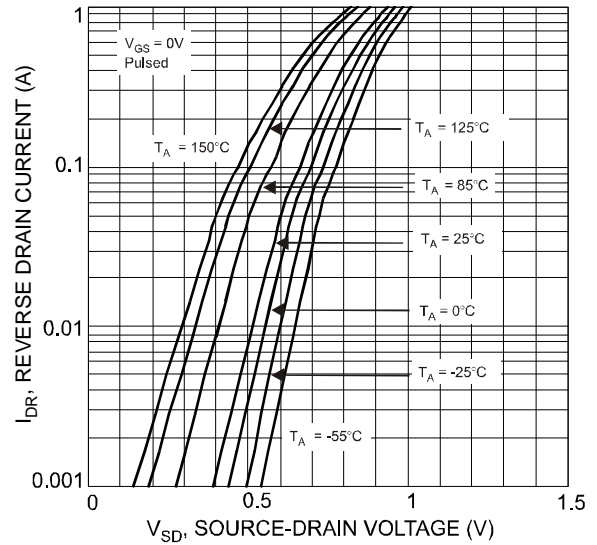

Fig. 8 Reverse Drain Current vs. Source-Drain Voltage

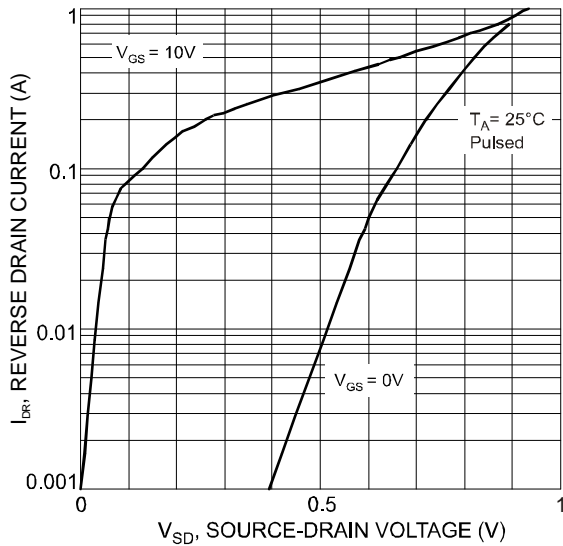

Fig. 9 Reverse Drain Current vs. Source-Drain Voltage

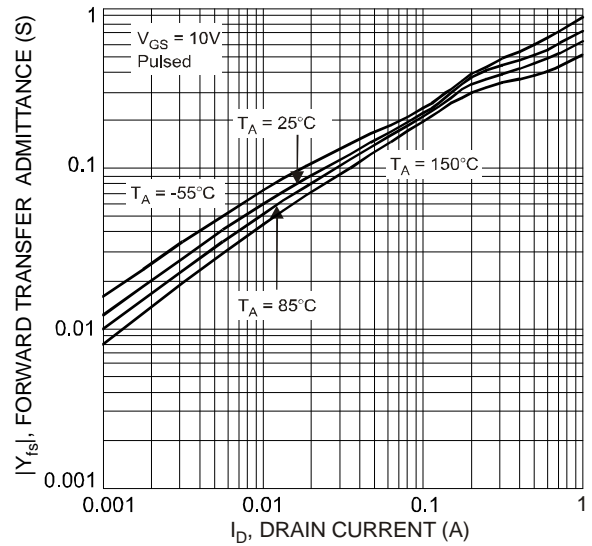

Fig. 10 Forward Transfer Admittance vs. Drain Current

**Ordering Information** (Note 6)

Part Number	Case	Packaging
DMN601DWK-7	SOT-363	3000/Tape & Reel

Notes: 6. For packaging details, go to our website at <http://www.diodes.com/datasheets/ap02007.pdf>.

**Marking Information**

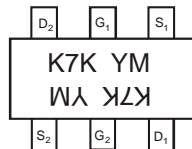

K7K = Marking Code  
YM = Date Code Marking  
Y = Year ex: S = 2005  
M = Month ex: 9 = September

Date Code Key

Year	2005	2006	2007	2008	2009	2010	2011	2012
Code	S	T	U	V	W	X	Y	Z

Month	Jan	Feb	Mar	Apr	May	Jun	Jul	Aug	Sep	Oct	Nov	Dec
Code	1	2	3	4	5	6	7	8	9	O	N	D

**Package Outline Dimensions**

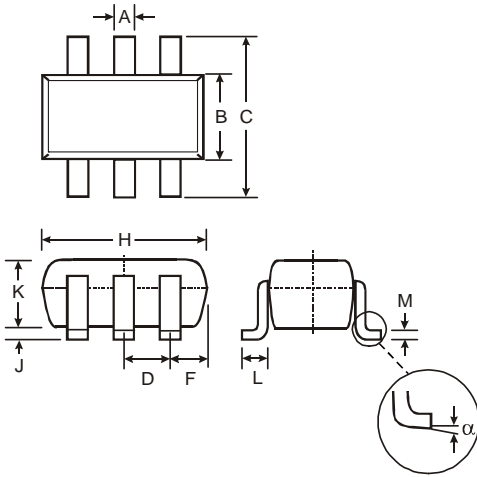

SOT-363		
Dim	Min	Max
A	0.10	0.30
B	1.15	1.35
C	2.00	2.20
D	0.65 Nominal	
F	0.30	0.40
H	1.80	2.20
J	—	0.10
K	0.90	1.00
L	0.25	0.40
M	0.10	0.25
α	0°	8°
All Dimensions in mm		

**Suggested Pad Layout**

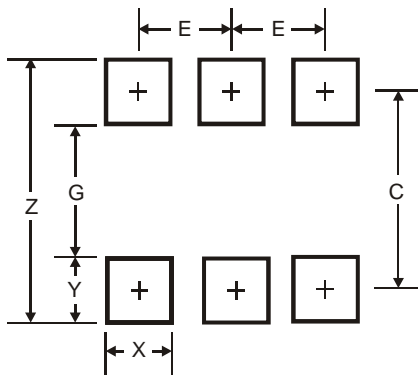

Dimensions	Value (in mm)
Z	2.5
G	1.3
X	0.42
Y	0.6
C	1.9
E	0.65

**IMPORTANT NOTICE**

Diodes Incorporated and its subsidiaries reserve the right to make modifications, enhancements, improvements, corrections or other changes without further notice to any product herein. Diodes Incorporated does not assume any liability arising out of the application or use of any product described herein; neither does it convey any license under its patent rights, nor the rights of others. The user of products in such applications shall assume all risks of such use and will agree to hold Diodes Incorporated and all the companies whose products are represented on our website, harmless against all damages.

**LIFE SUPPORT**

Diodes Incorporated products are not authorized for use as critical components in life support devices or systems without the expressed written approval of the President of Diodes Incorporated.